

SMALL GIFFARD CLOUD INSTALL GUIDE



www.crownsurfacesolutions.com
e: info@crownsurfacesolutions.com
p: 416.245.2900

SMALL GIFFARD CLOUD

ASSEMBLY

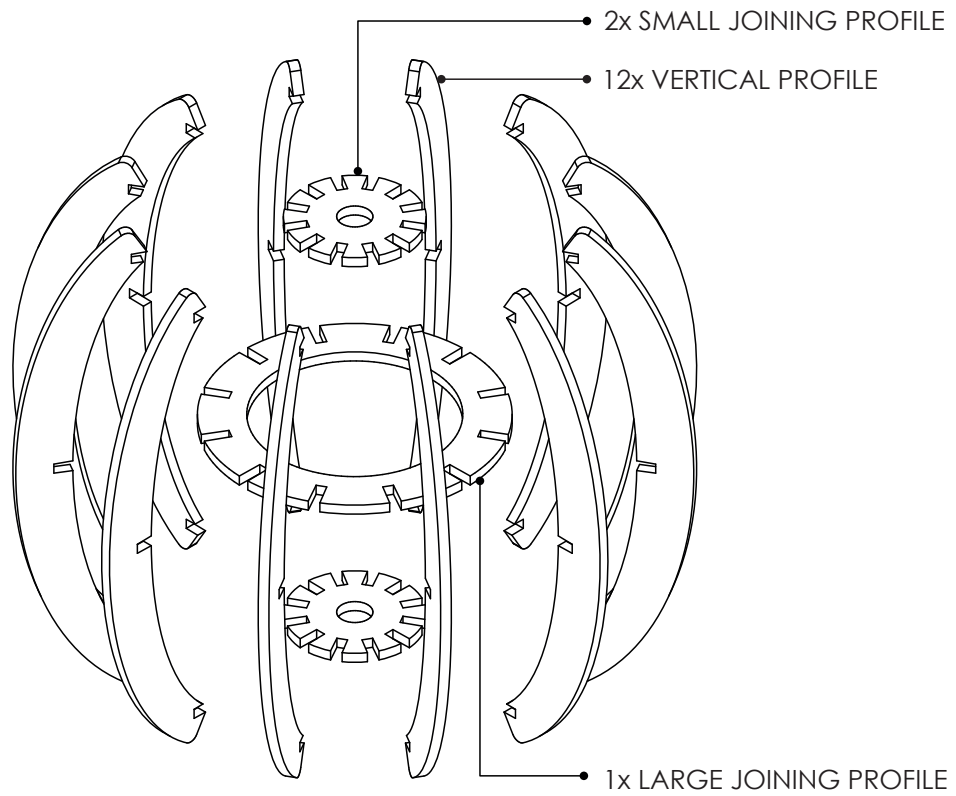

1) Assemble cloud profiles as shown.

STEP 1

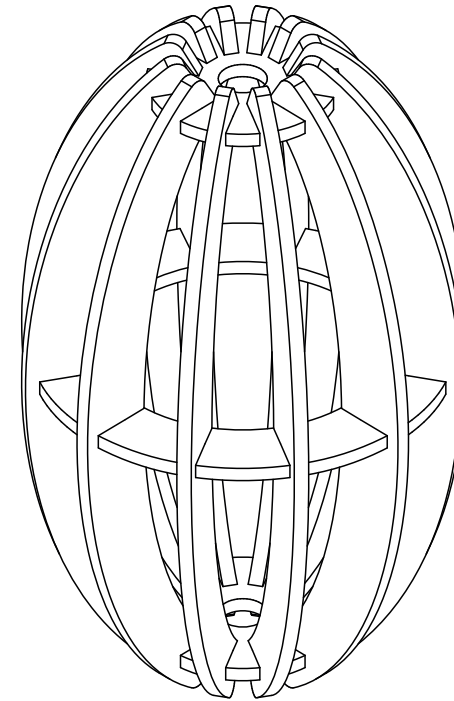

2) Assembly is complete.

STEP 2

SMALL GIFFARD CLOUD SUSPENSION METHOD

3) Place cloud assembly up to ceiling in desired location. Mark position of **1 x** through hole which corresponds to the centre of the cloud.

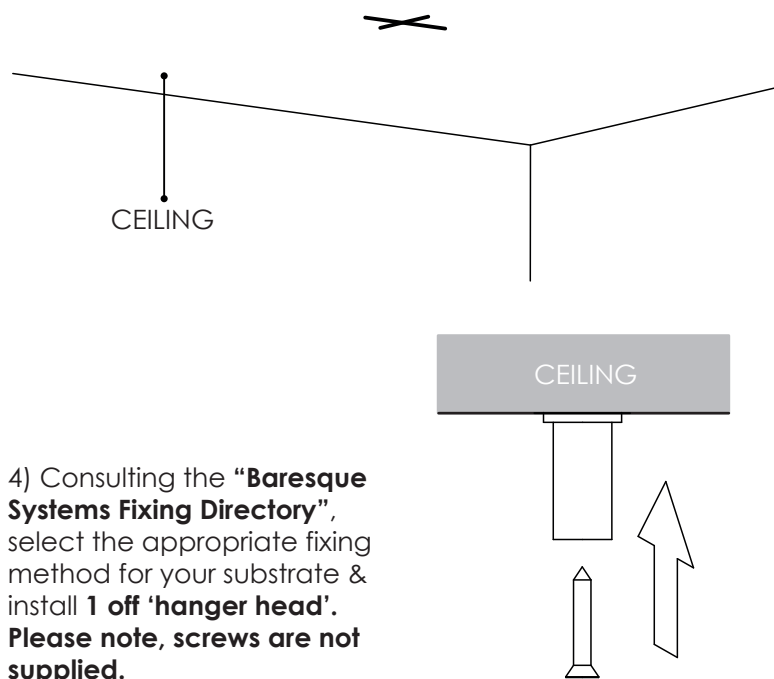

4) Consulting the “**Baresque Systems Fixing Directory**”, select the appropriate fixing method for your substrate & install **1 off ‘hanger head’**. **Please note, screws are not supplied.**

STEP 3 & 4

5) Feed swaged wire through tip of ‘wire adjuster’ (as shown). Push button (shown in grey) to adjust wire length. Release the button to lock in place.

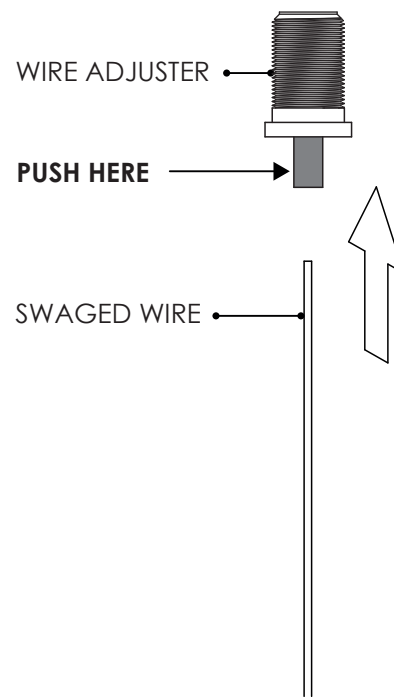

6) Feed swaged wire through hole in the side of ‘hanger head’. Screw ‘wire adjuster’ into ‘hanger head’. Adjust wire to desired length.

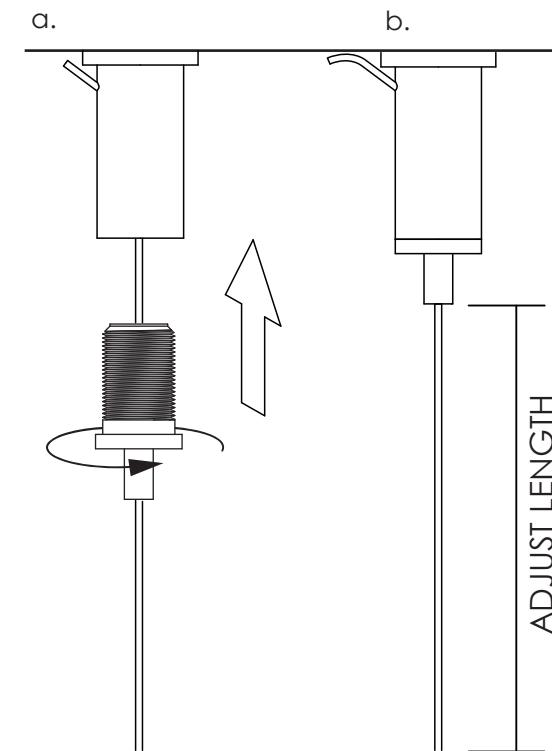

STEP 5 & 6

SMALL GIFFARD CLOUD SUSPENSION METHOD

7) Insert 'S' hooks into mounting slits on cloud as shown.

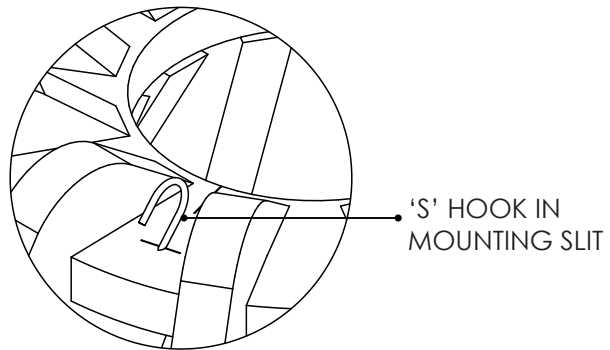

8) Suspend cloud by looping 'S' hooks through swaged wire. Note- 2 'S' hooks are required per wire.

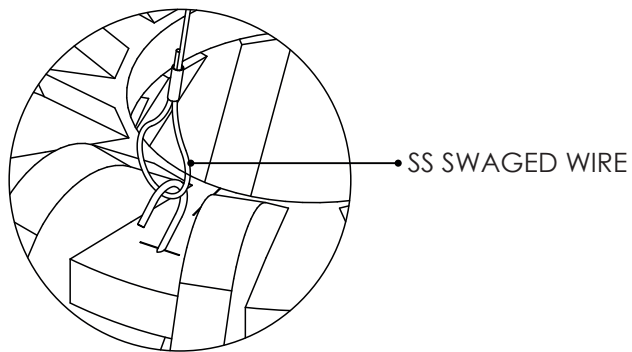

STEP 7 & 8

9) Re-adjust wire length as explained in STEP 5 until you are satisfied with the hanging height. Note, there are 2 orientation options as shown below.

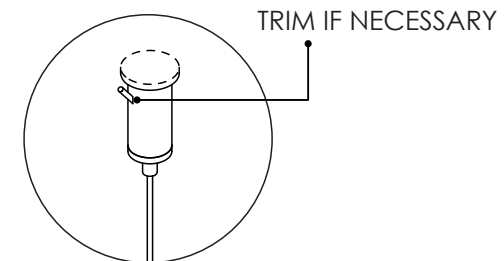
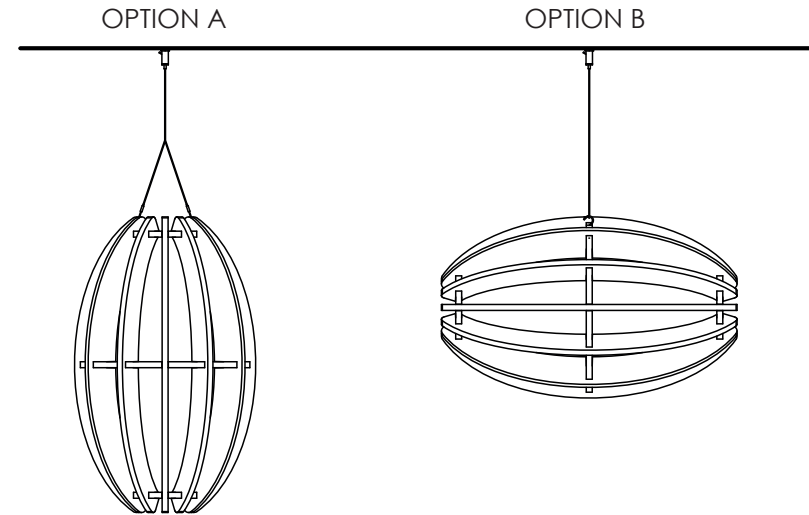

STEP 9

*Please note, above linework is representative only. Your cloud may not be depicted.

SMALL GIFFARD CLOUD PARTS

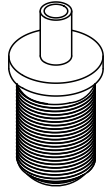

WIRE ADJUSTER
1 OFF

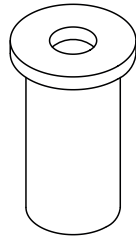

HANGER HEAD
1 OFF

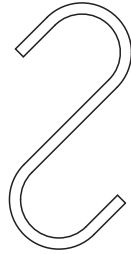

'S' HOOK
2 OFF

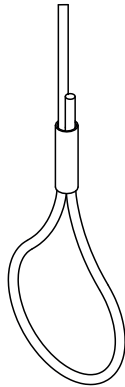

SWAGED WIRE Y-FIT
1 OFF

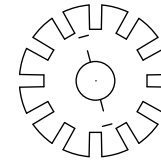

SMALL JOINING PROFILE
2 OFF

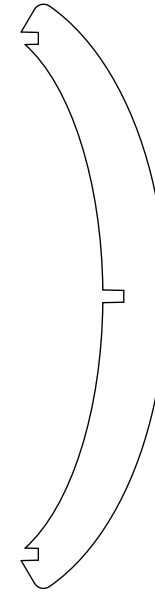

VERTICAL PROFILE
12 OFF

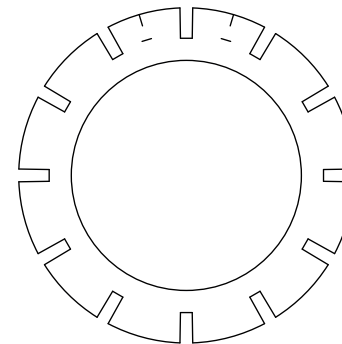

LARGE JOINING PROFILE
1 OFF